

CSCI 420 Computer Graphics
Lecture 24

Non-Photorealistic Rendering

Pen-and-ink Illustrations
Painterly Rendering
Cartoon Shading
Technical Illustrations

Jernej Barbic
University of Southern California

Goals of Computer Graphics

- Traditional: Photorealism
 - Sometimes, we want more
 - Cartoons
 - Artistic expression in paint, pen-and-ink
 - Technical illustrations
 - Scientific visualization
- [Lecture next week]



cartoon shading

Non-Photorealistic Rendering

“A means of creating imagery that does not aspire to realism” - Stuart Green



Cassidy Curtis 1998



David Gainey

Non-photorealistic Rendering

Also called:

- Expressive graphics
- Artistic rendering
- Non-realistic graphics
- Art-based rendering
- Psychographics



Source: ATI

Some NPR Categories

- **Pen-and-Ink illustration**
 - Techniques: cross-hatching, outlines, line art, etc.
- **Painterly rendering**
 - Styles: impressionist, expressionist, pointilist, etc.
- **Cartoons**
 - Effects: cartoon shading, distortion, etc.
- **Technical illustrations**
 - Characteristics: Matte shading, edge lines, etc.
- **Scientific visualization**
 - Methods: splatting, hedgehogs, etc.

Outline

- Pen-and-Ink Illustrations
- Painterly Rendering
- Cartoon Shading
- Technical Illustrations

Hue

- Perception of “distinct” colors by humans
- Red • Green
- Blue • Yellow



0 60 120 180 240 300 360

Hue Scale

Source: Wikipedia

Tone

- Perception of “brightness” of a color by humans
- Also called lightness
- Important in NPR

lighter

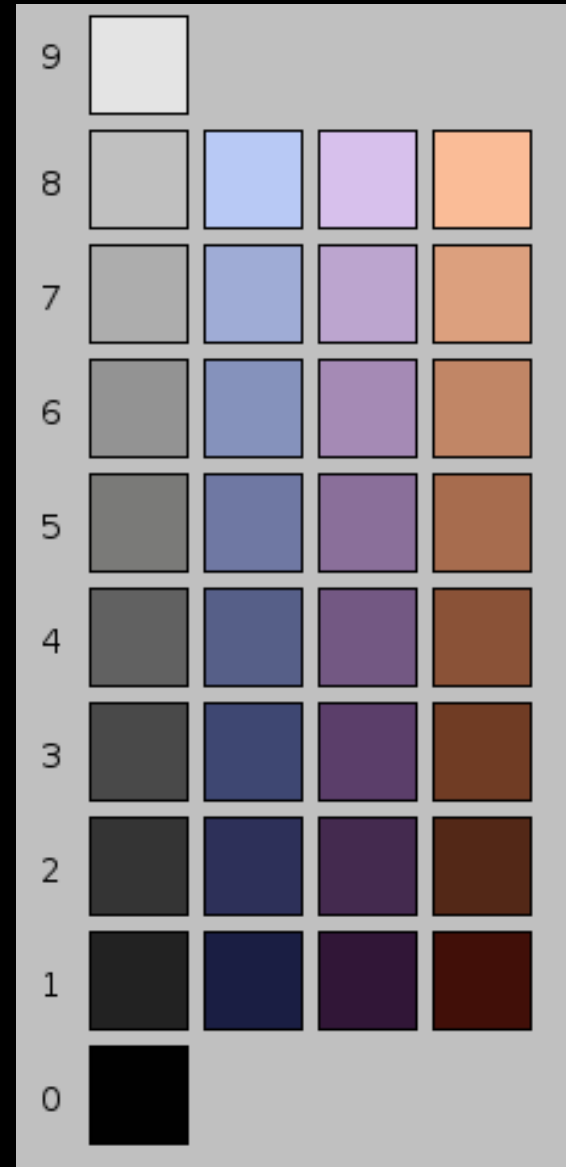

darker

Source: Wikipedia

Pen-and-Ink Illustrations

Winkenbach and
Salesin 1994

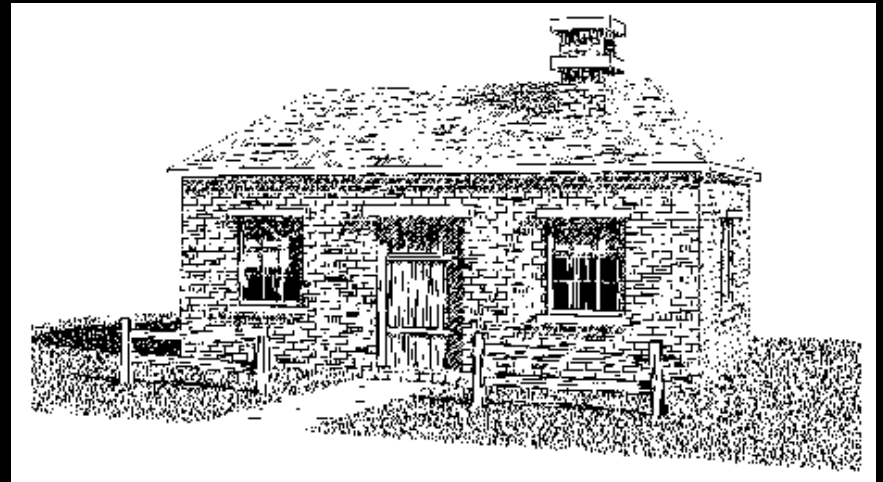
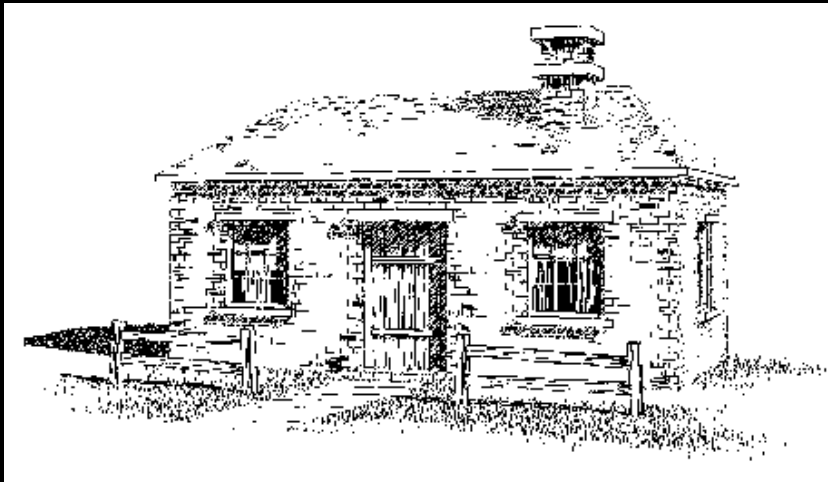
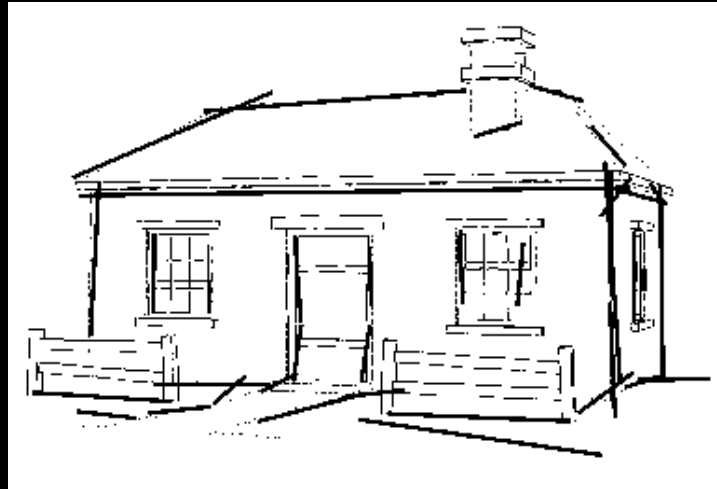

Pen-and-Ink Illustrations

- **Strokes**
 - Curved lines of varying thickness and density
- **Texture**
 - Conveyed by collection of strokes
- **Tone**
 - Perceived gray level across image or segment
- **Outline**
 - Boundary lines that disambiguate structure



Winkenbach and
Salesin 1994

Rendering Pipeline: Polygonal Surfaces with NPR

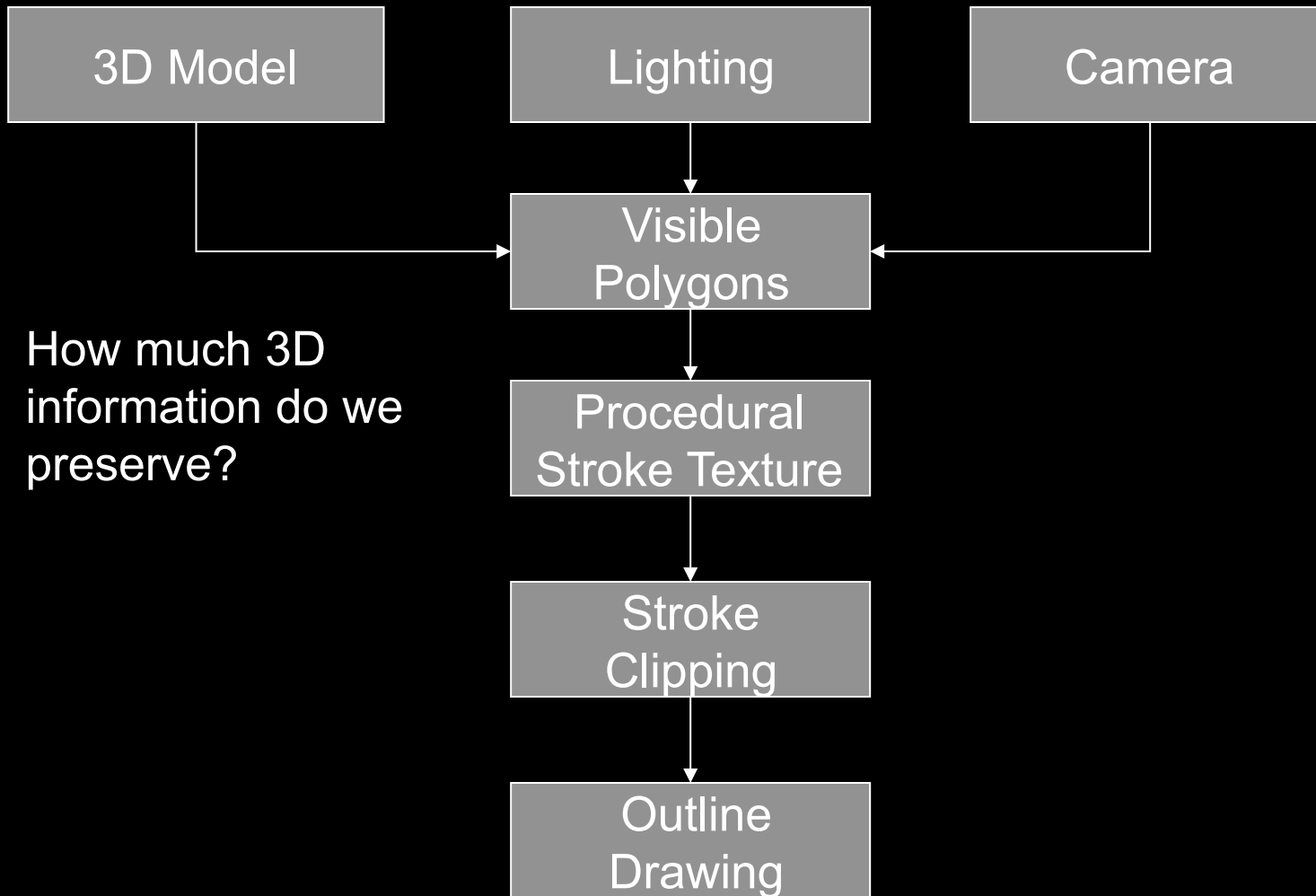

Strokes and Stroke Textures

- Stroke generated by moving along straight path
- Stroke perturbed by
 - Waviness function (straightness)
 - Pressure function (thickness)
- Collected in **stroke textures**
 - Tone dependent
 - Resolution dependent
 - Orientation dependent
- How automatic are stroke textures?

Stroke Texture Examples

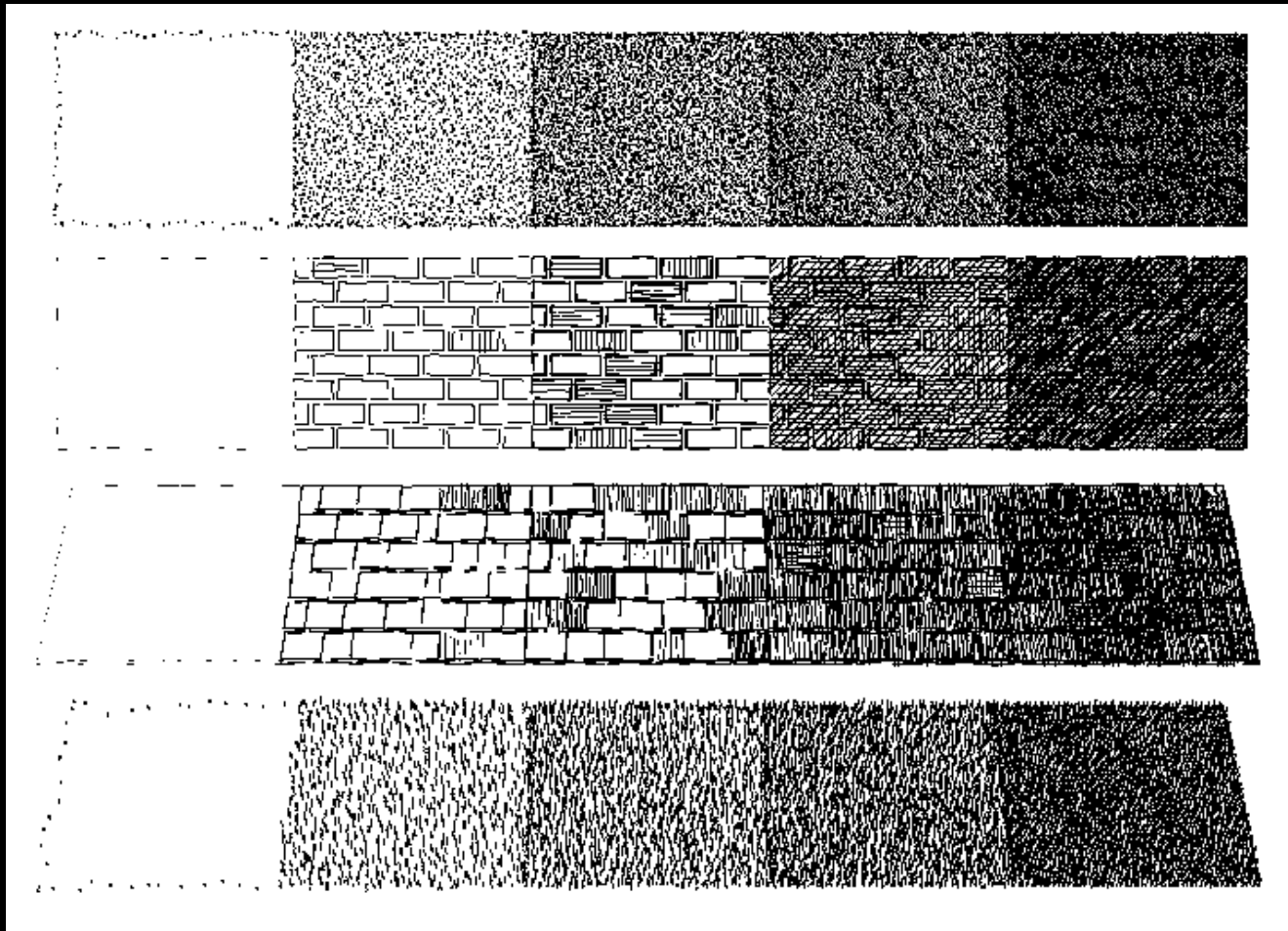

Winkenbach and Salesin 1994

Stroke Texture Operations

Scaling

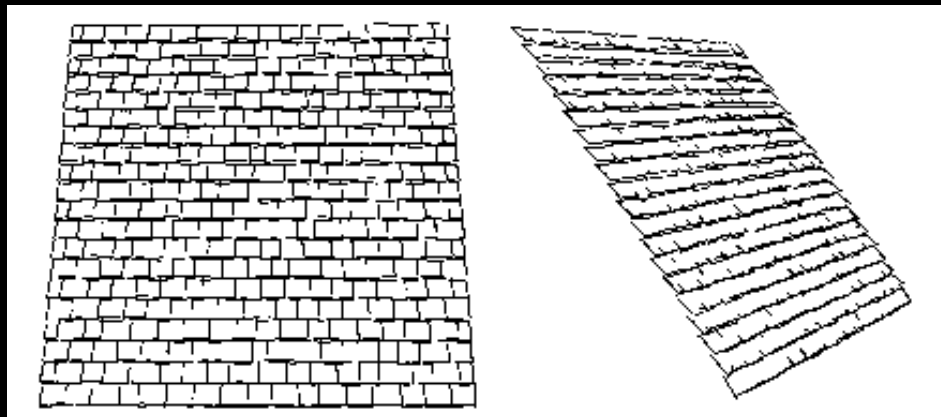
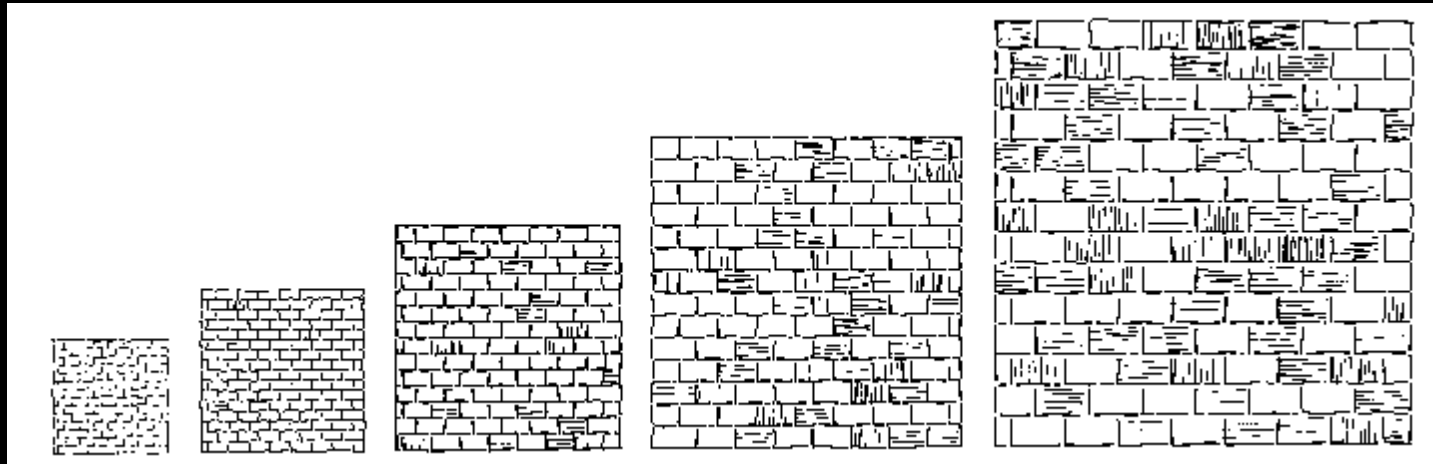

Changing Viewing Direction (Anisotropic)

Indication

- Selective addition of detail
- Difficult to automate
- User places detail segments interactively

Indication Example

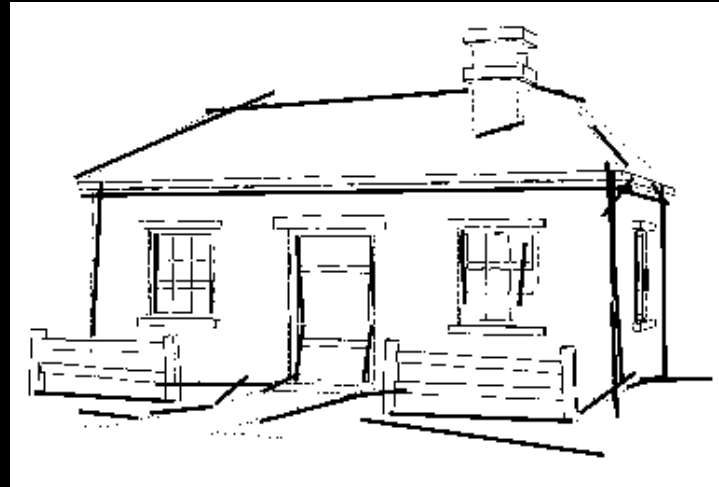

Input without
detail

With indication

Without indication

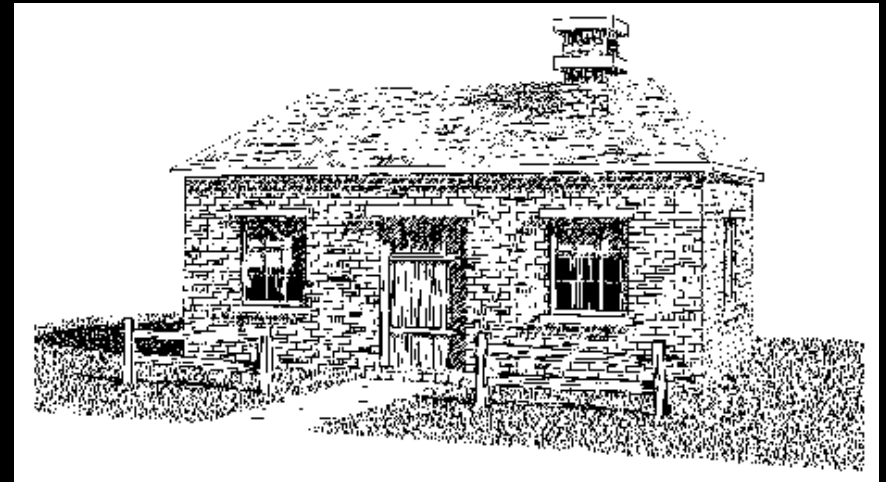
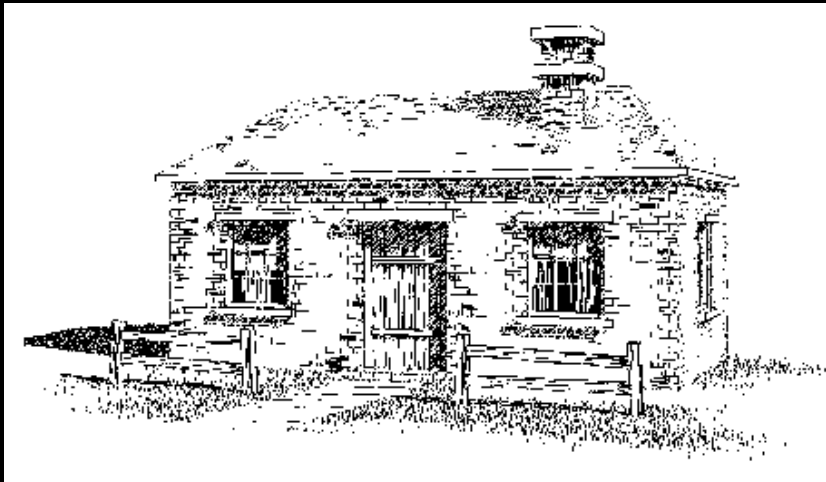

Outlines

- Boundary or interior outlines
- Accented outlines for shadowing and relief
- Dependence on viewing direction
- Suggest shadow direction

Rendering Parametric Surfaces

- Stroke orientation and density
 - Place strokes along isoparametric lines
 - Choose density for desired tone
 - $\text{tone} = \text{spacing} / \text{width}$

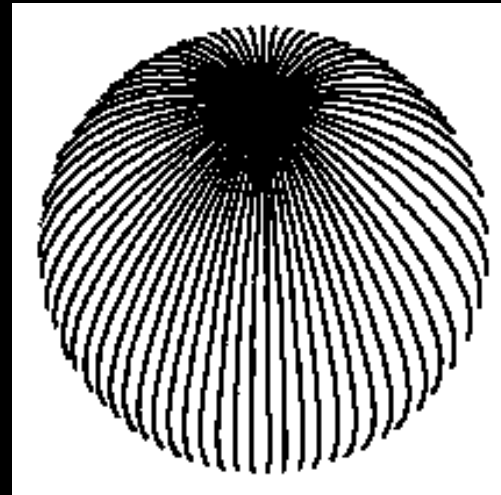
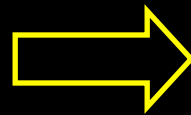
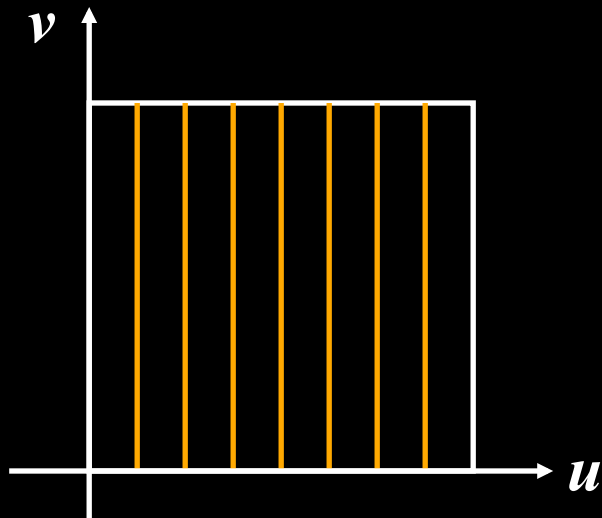

Parametric Surface Example

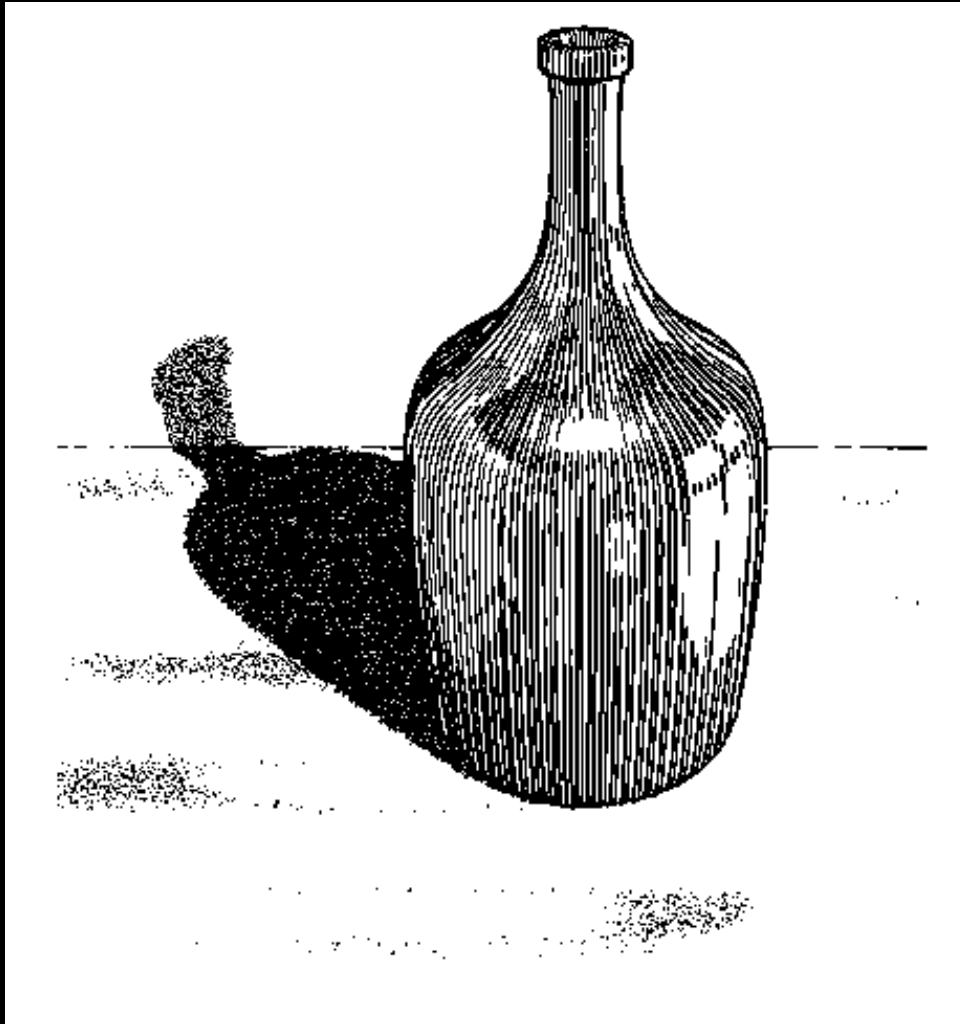

Winkenbach and
Salesin 1996

Hatching + standard rendering

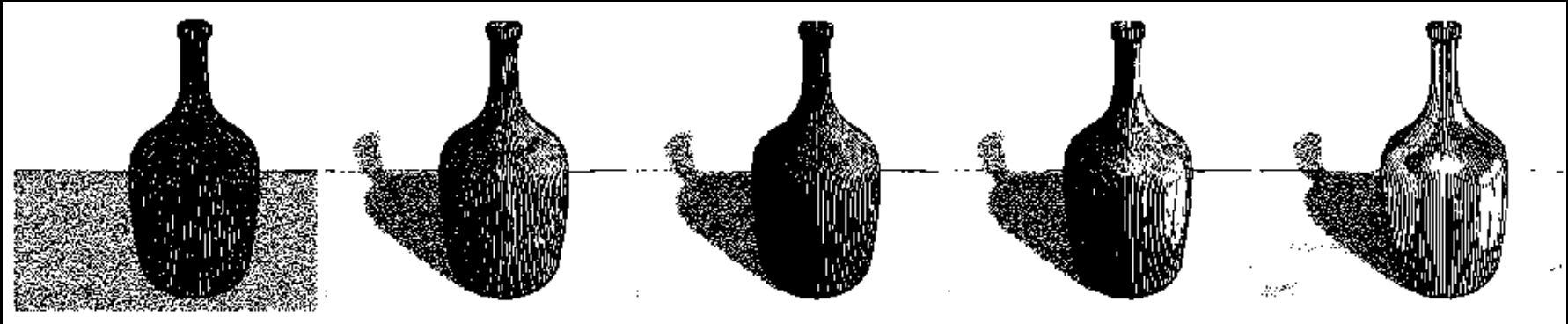

Constant-density
hatching

Smooth shading
with single light

Longer smoother
strokes for glass

Environment
mapping

Varying reflection
coefficient

Standard rendering techniques are still important!

Orientable Textures

- Inputs
 - Grayscale image to specify desired tone
 - Direction field
 - Stroke character
- Output
 - Stroke shaded image

Salisbury et al. 1997

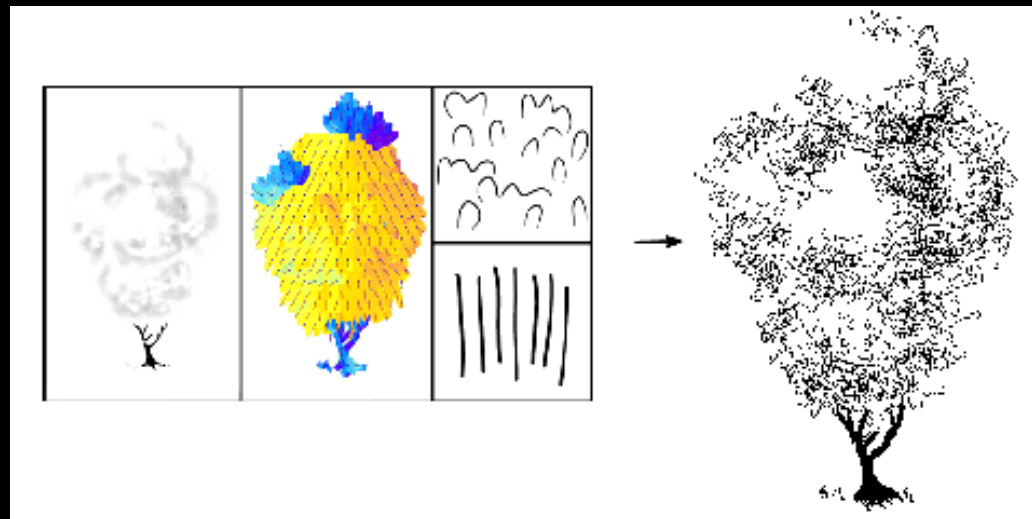

Orientable Stroke Texture Example

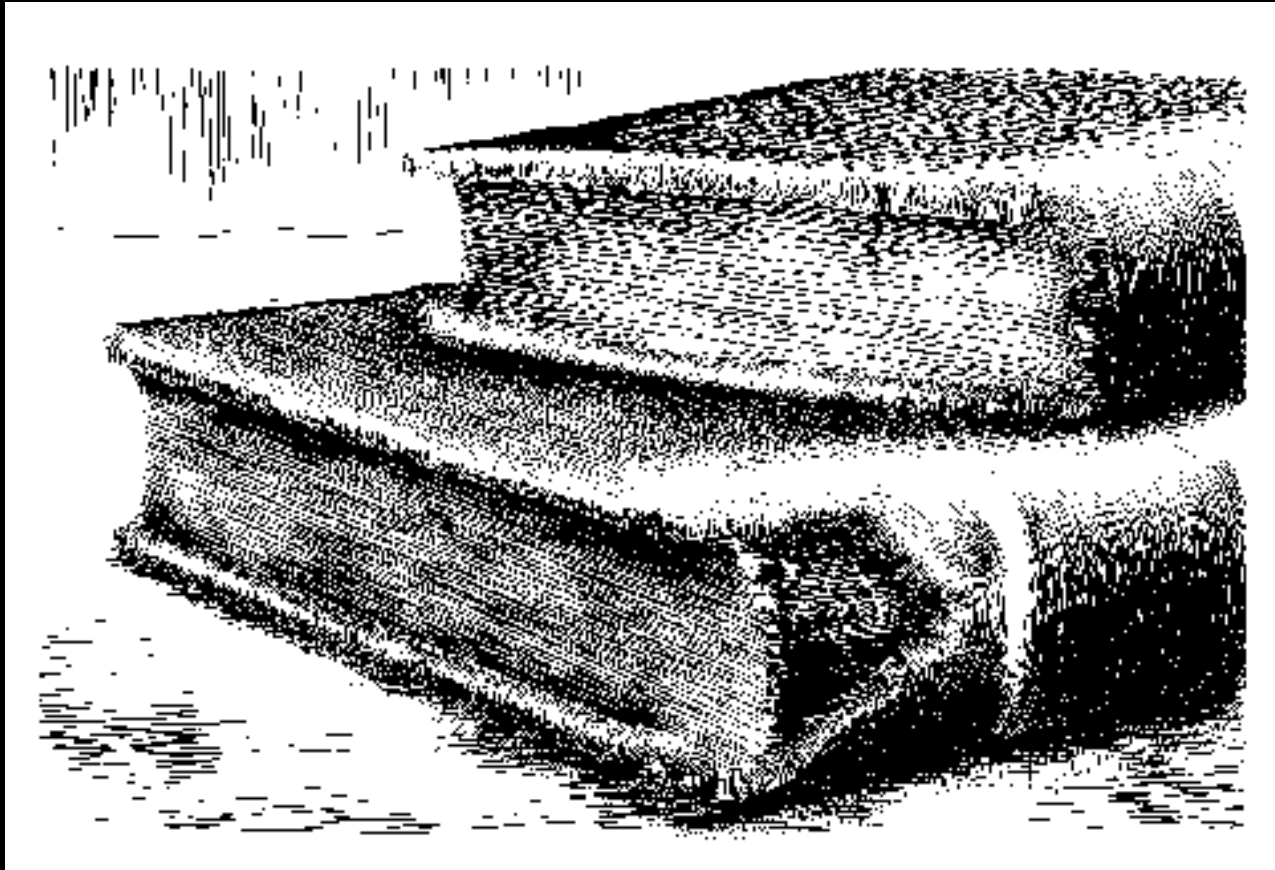

Salisbury et al. 1997

Outline

- Pen-and-Ink Illustrations
- **Painterly Rendering**
- Cartoon Shading
- Technical Illustrations

Painterly Rendering

- Physical simulation
 - User applies brushstrokes
 - Computer simulates media (paper + ink)
- Automatic painting
 - User provides input image or 3D model
 - User specifies painting parameters
 - Computer generates all strokes

Physical Simulation Example



Curtis et al. 1997, *Computer Generated Watercolor*

Computer-Generated Watercolor

- Complex physical phenomena for artistic effect
- Build simple approximations
- Paper generation as random height field

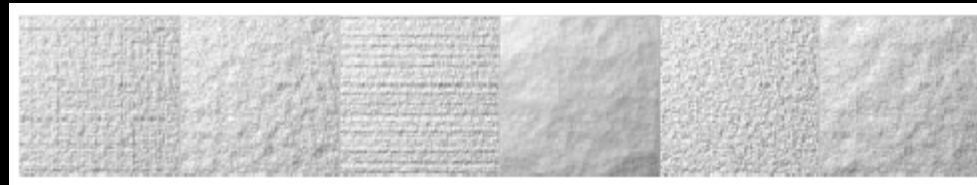

- Simulated effects

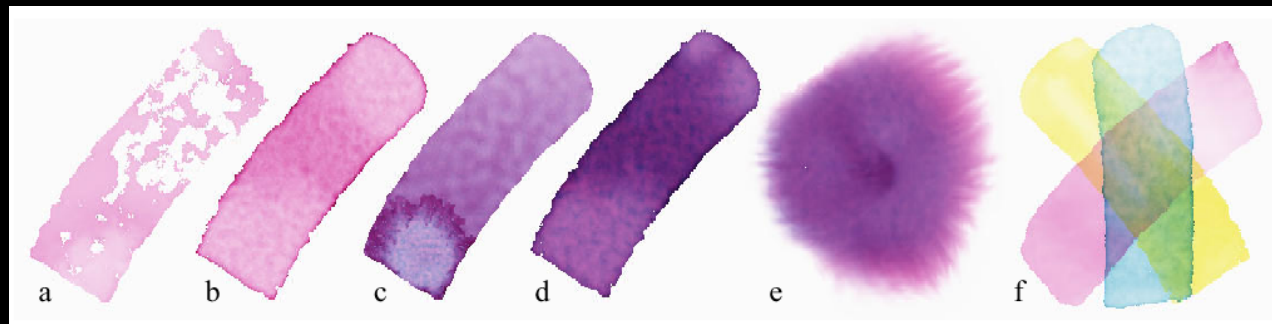

Fluid Dynamic Simulation

- Use water velocity, viscosity, drag, pressure, pigment concentration, paper gradient
- Paper saturation and capacity

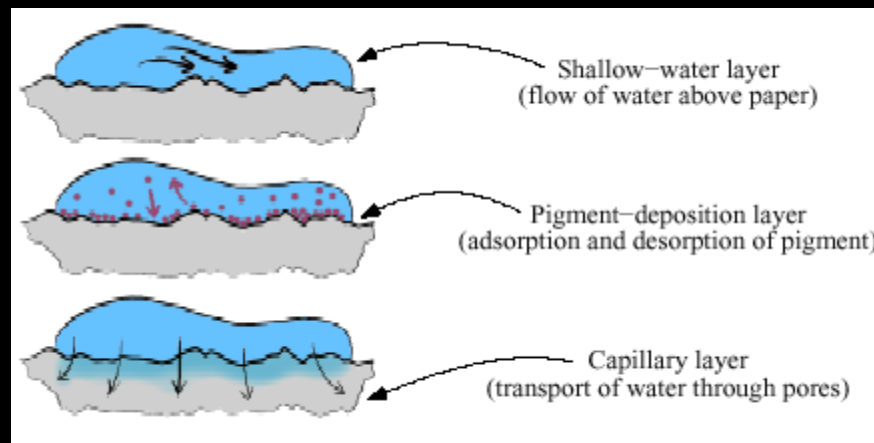

- Discretize and use cellular automata

Interactive Painting

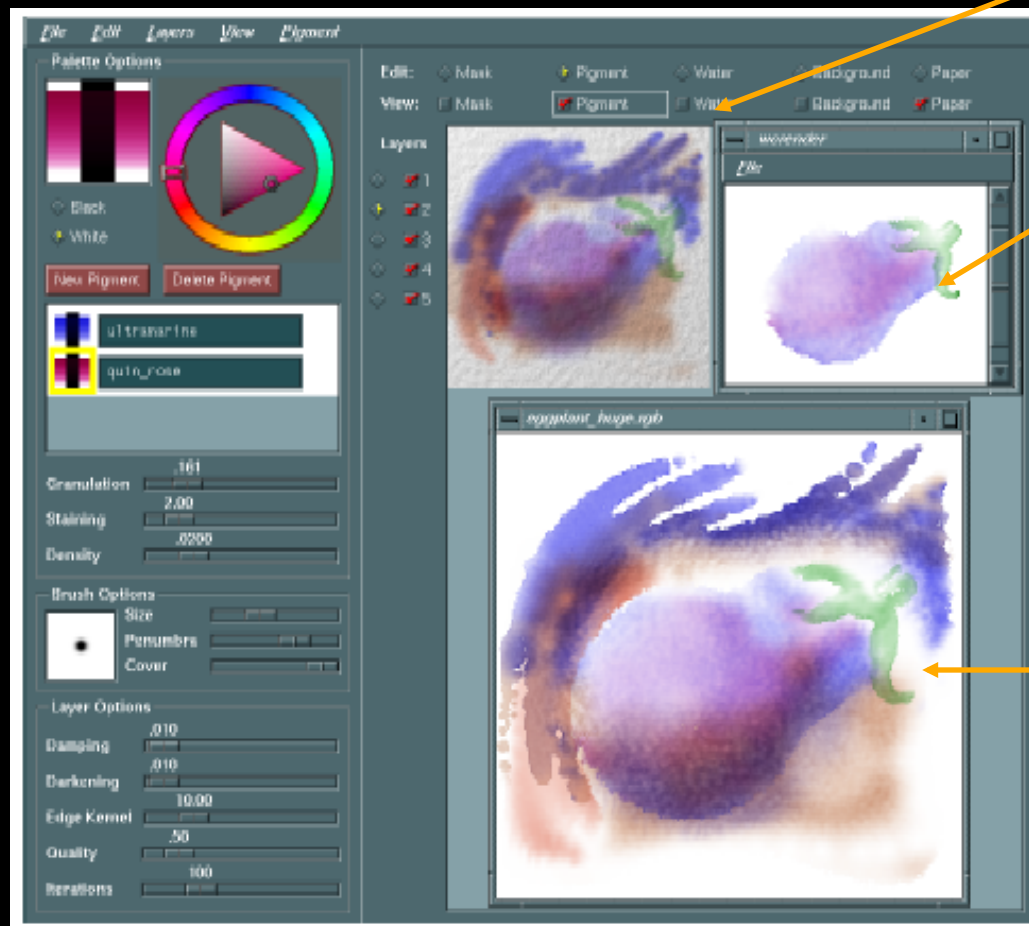

User input

Simulation in progress

Finished painting

Automatic Painting Example



Hertzmann 1997

Automatic Painting from Images

- Start from color image: no 3D information
- Paint in resolution-based layers
 - Blur to current resolution
 - Select brush based on current resolution
 - Find area of largest error compared to real image
 - Place stroke
 - Increase resolution and repeat
- Layers are painted coarse-to-fine
- Styles controlled by parameters

Layered Painting



Blurring



Adding detail with smaller strokes



Painting Styles

- Style determined by parameters
 - Approximation thresholds
 - Brush sizes
 - Curvature filter
 - Blur factor
 - Minimum and maximum stroke lengths
 - Opacity
 - Grid size
 - Color jitter
- Encapsulate parameter settings as style

Style Examples



Source image



“Impressionist”

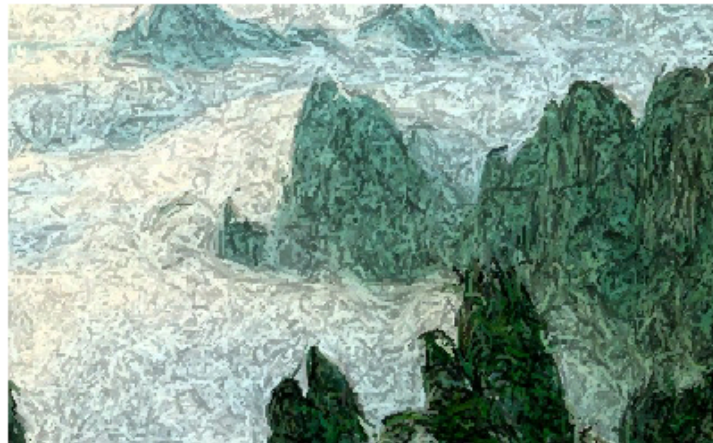

“Expressionist”



“Pointillist”

Some Styles

- “Impressionist”
 - No random color, $4 \leq \text{stroke length} \leq 16$
 - Brush sizes 8, 4, 2; approximation threshold 100
- “Expressionist”
 - Random factor 0.5, $10 \leq \text{stroke length} \leq 16$
 - Brush sizes 8, 4, 2; approximation threshold 50
- “Pointilist”
 - Random factor ~ 0.75 , $0 \leq \text{stroke length} \leq 0$
 - Brush sizes 4, 2; approximation threshold 100
- Not completely convincing to artists (yet?)

Outline

- Pen-and-Ink Illustrations
- Painterly Rendering
- **Cartoon Shading**
- Technical Illustrations

Cartoon Shading

- Shading model in 2D cartoons
 - Use material color and shadow color
 - Present lighting cues, shape, and context
- Stylistic
- Used in many animated movies
- Real-time techniques for games

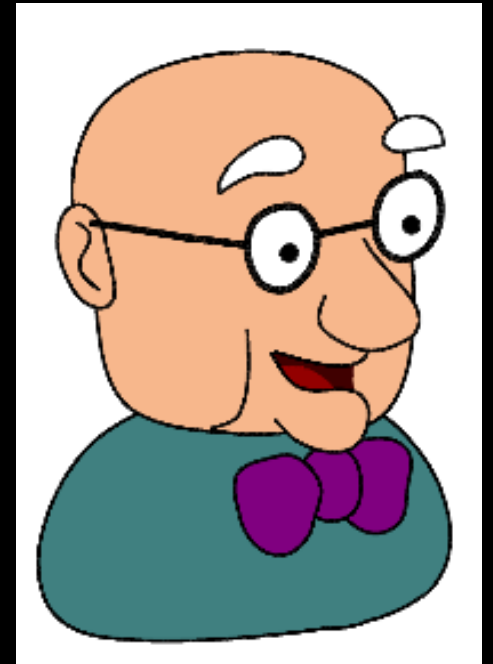

Source:
Alec Rivers

Cartoon Shading as Texture Map

- Apply shading as 1D texture map

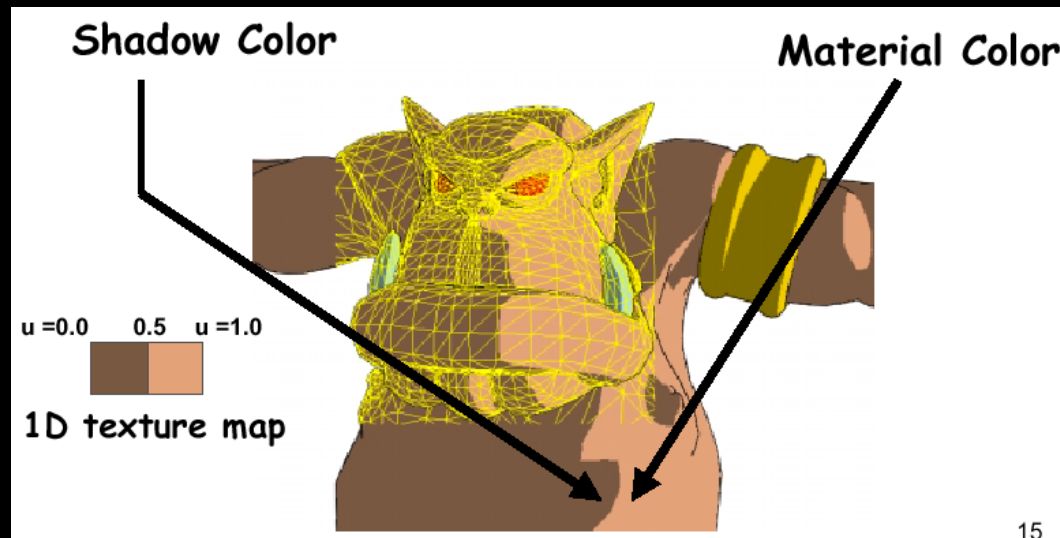

- Two-pass technique:
Pass 1: standard shader
Pass 2: use result from 1 as texture coordinates

Carl Marshall 2000

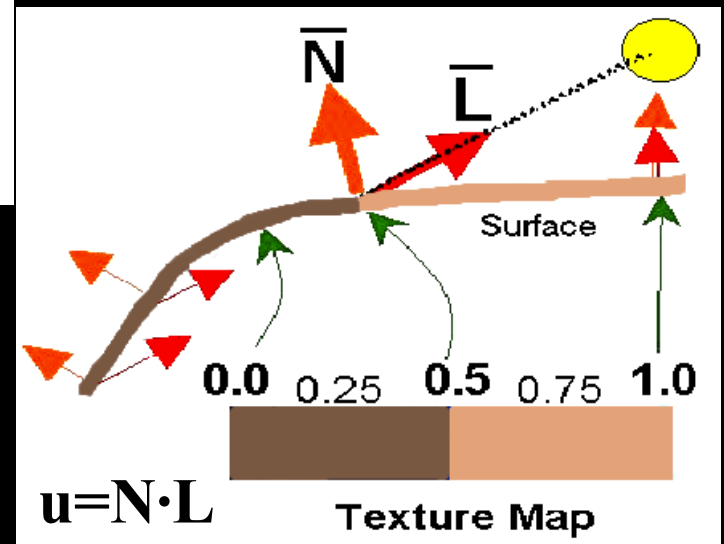

Shading Variations

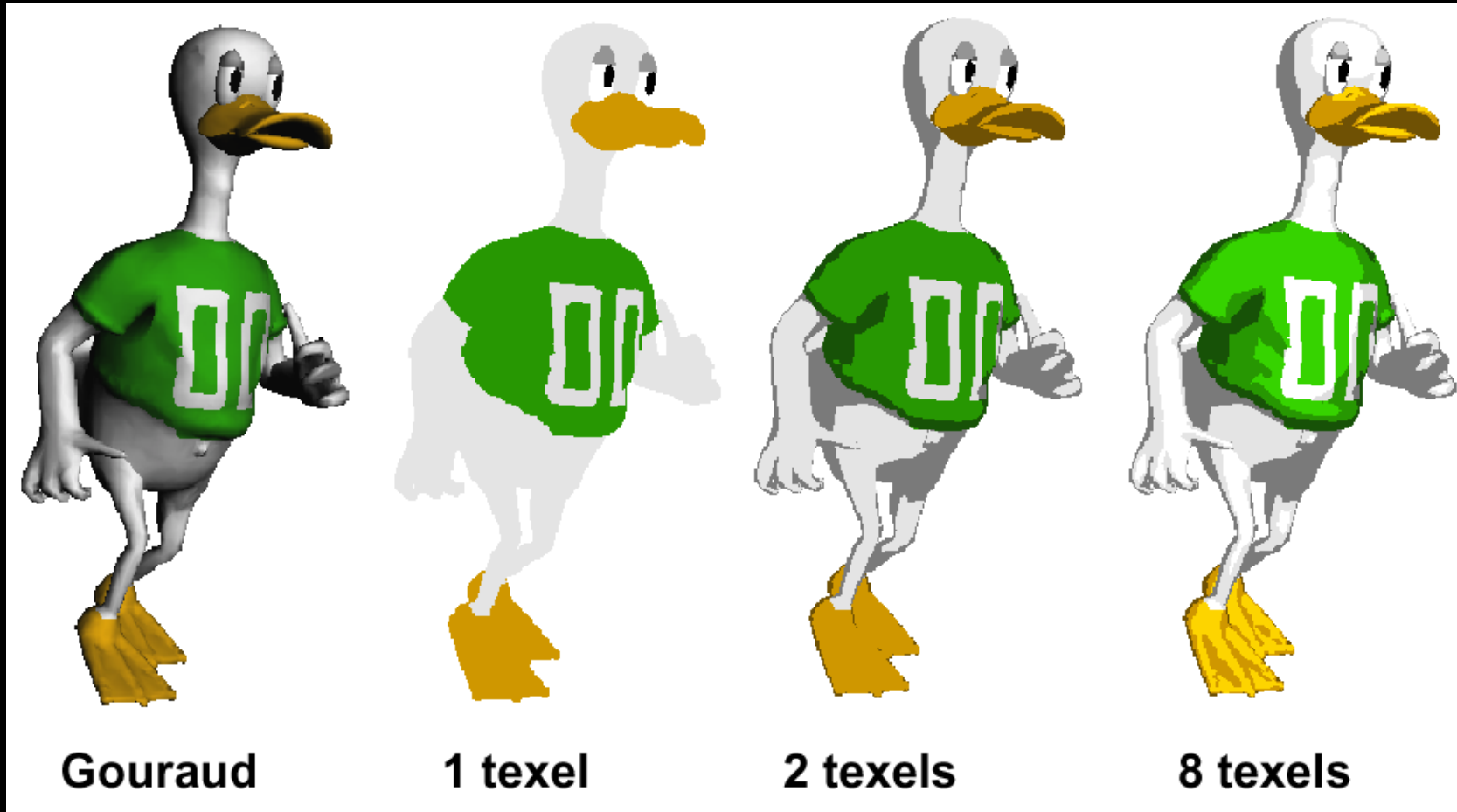

Gouraud

1 texel

2 texels

8 texels

Flat shading

Shadow

Shadow + highlight

Outline

- Pen-and-Ink Illustrations
- Painterly Rendering
- Cartoon Shading
- **Technical Illustrations**

Technical Illustrations

- Level of abstraction
 - Accent important 3D properties
 - Dimish or eliminate extraneous details
- Do not represent reality

Ruppel 1995



Photo

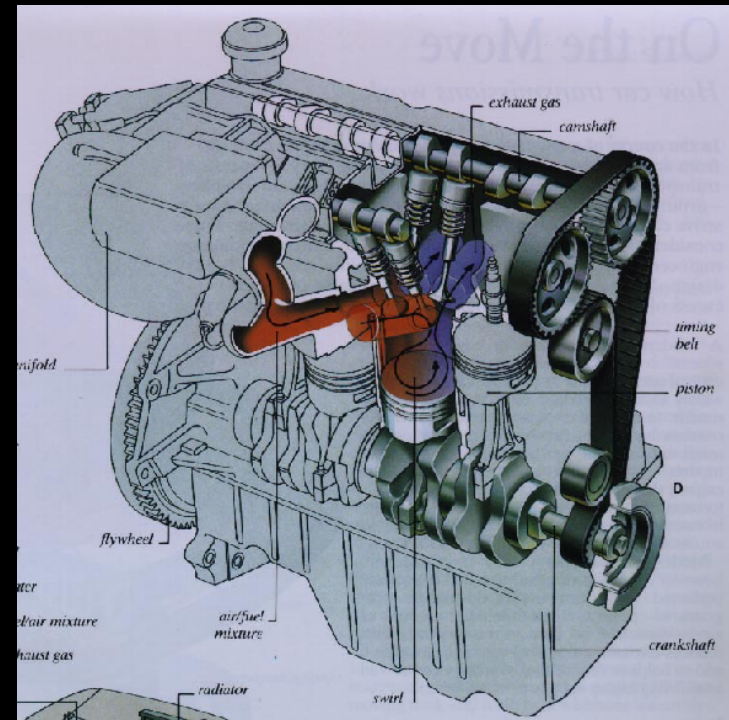

Conventions in Technical Illustrations

- Black edge lines
- Cool to warm shading colors
- Single light source; shadows rarely used

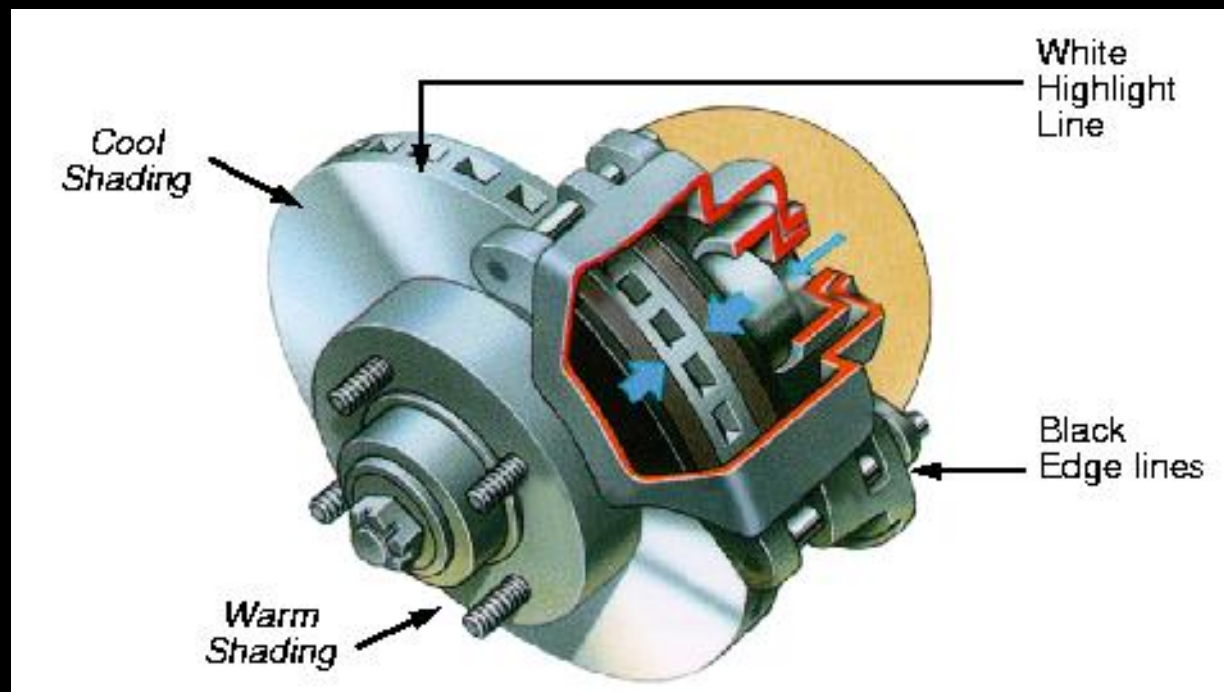

Technical Illustration Example

Phong shading

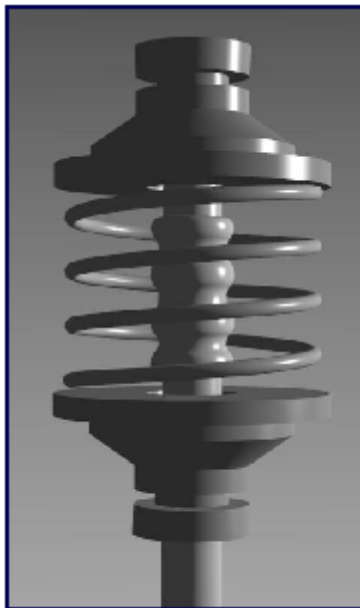

Metal shading
(anisotropic)

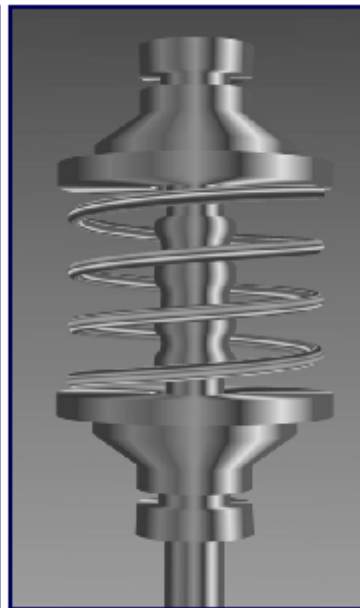

Edge lines

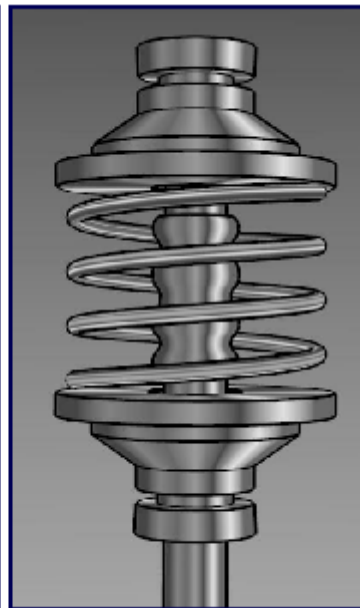

Gooch shading
(cool to warm shift
gives better depth
perception)

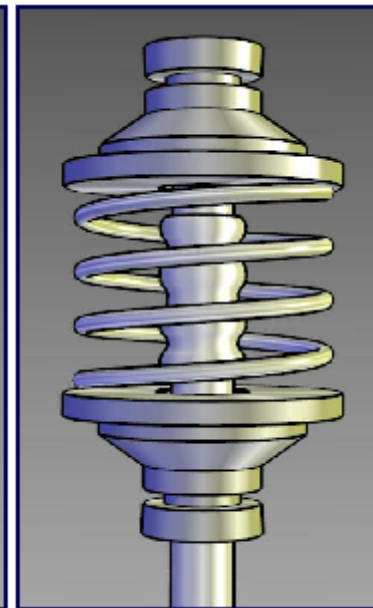

Source: Bruce Gooch

The Future

- Smart graphics
 - Design from the user' s perspective
 - HCI, AI, Perception
- Artistic graphics
 - More tools for the creative artist
 - New styles and ideas

Summary

- Beyond photorealism
 - Artistic appeal
 - Technical explanation and illustration
 - Scientific visualization
- Use all traditional computer graphics tools
- Employ them in novel ways
- Have fun!